

# CLLEEN™ FRAC

Solution for Oil, Gas & Energy Sector

by **CLLEEN™** Water and Power

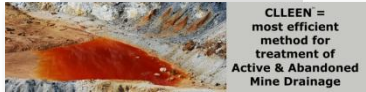

[www.waterdesalinationplants.com](http://www.waterdesalinationplants.com)

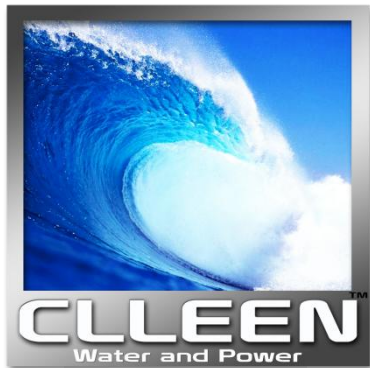

# Oil and Water

*“US oil production includes an average of 10 barrels of water for each barrel of oil produced. Handling and disposal of this water is the single greatest environmental impediment to domestic oil production.”* US Department of Energy

## CLLEEN™ FRAC solution – processes most difficult of process waters including:

- High concentration of solids
- Heavy salt concentrations

## Flow rates can exceed:

- 1 megaliter per day (288,000 US gallons/day)
- Operates 24 / 7 / 365

## Suitable for:

- Produced & frac water pond clean up
- Frac water generally



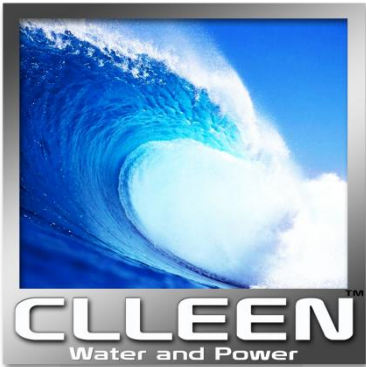

# How does a 6 step advanced Oil and Gas CLLEEN™ FRAC water treatment process work?

www.waterdesalinationplants.com



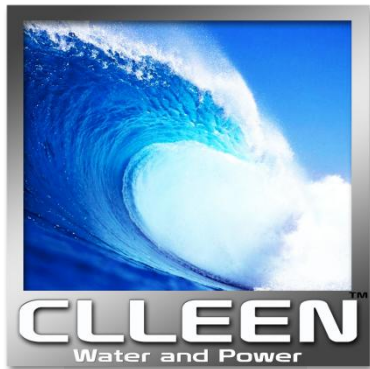

## 1. Electrocoagulation (EC)

### Non-chemical coagulation process separates:

- Silica
- Silt
- Colloidal contaminants
- Emulsified oils
- Organic Materials
- Heavy metals
- Bacteria
- and processed chemicals

## 2. Ultra Filtration (UF)

- Ceramic UF for effective secondary separation of coagulated materials and freed oils from EC treated waters

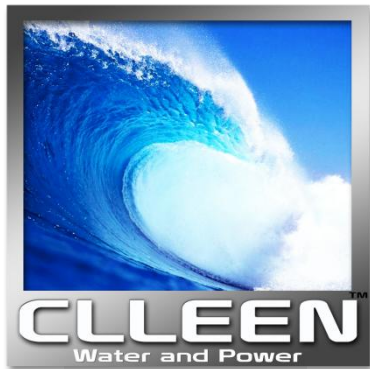

### 3. Vacuum Clarification (VC)

- Recover freed oils
- Separate solids
- Recapture cleaned brine water from UF reject

### 4. CLLEEN™ Multi-stage Flash Distillation (MSF)

- Separate large quantities TDS that have been treated and passed through by the EC, UF and VC

### 5. CLLEEN™ Crystallization

- Use of CLLEEN™ MSF with atmospheric vapor release to treat concentrated distillation reject stream and produce crystallized salt
- Deep well injection of brine is unnecessary

### 6. Sludge treatment

- Proprietary blend of specialty enzymes and organic soil amendments
- Conversion of sludge to organic fertilizer



# CLLEEN™ FRAC Water Treatment System

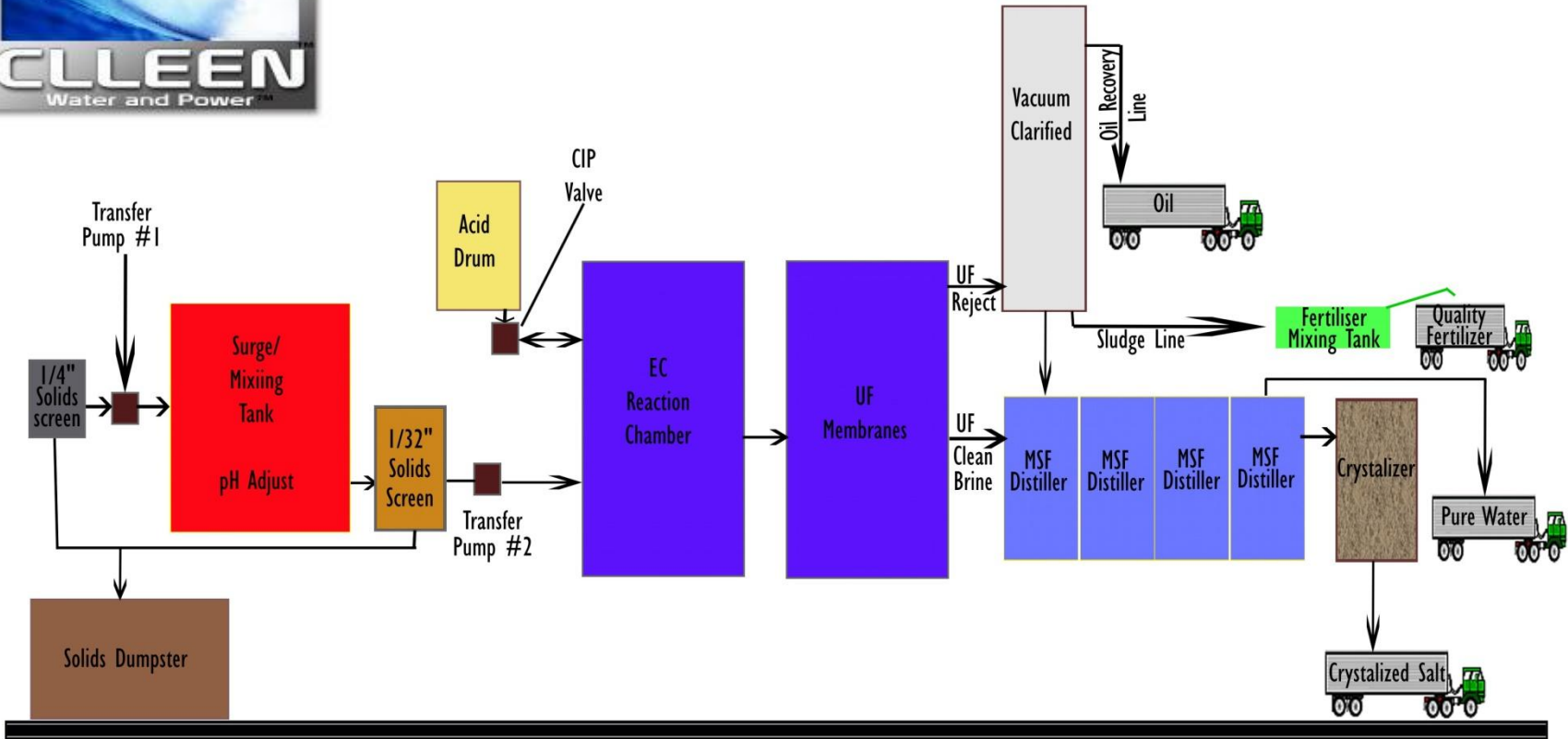

www.waterdesalinationplants.com

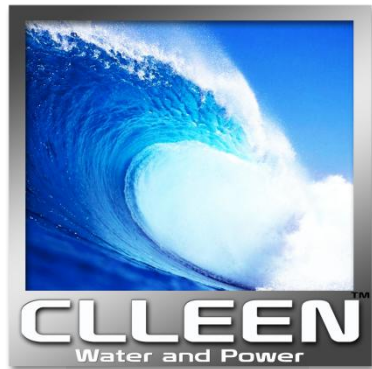

## BENEFITS FOR YOU!

- Our bio-friendly sludge passes US EPA TCLP (leachable analysis)
  - is considered non-hazardous
  - and can be land-applied
  - or used as clean fill
- No expensive disposal of sludge in a hazardous landfill
- No trucking and expensive deep-well injection of brine
- The most cost-effective, environmentally friendly & community friendly Zero Liquid Discharge (ZLD) & Zero Solids Discharge solution
- Eliminate community fears & negative media coverage of 'earthquake-causing' deep-well injection of brine
- Eliminate community fears & negative media coverage of heavy metal leakage from hazardous landfills



# CLLEEN™ FRAC Results

## Recovery of 80% of water

- Ultra pure distilled form of water
- Ecologically friendly sludge
- Clean salt
- Clean oil
- 100% recycle

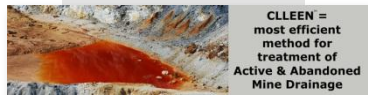
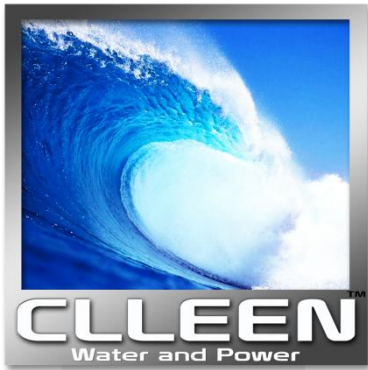

www.waterdesalinationplants.com

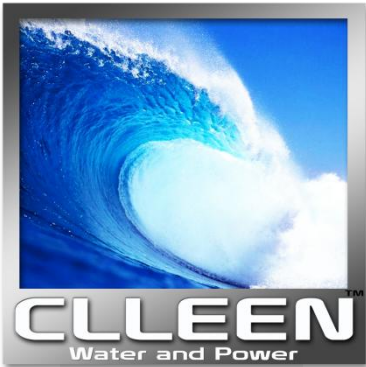

CLLEEN provides water desalination solutions for cities

Cost savings in  
 \*set up  
 \*production  
 \*maintenance  
 \*management  
 \*labour  
 for industrial waste water management

CLLEEN™ Water Treatment System for Frac Water

CLLEEN = most efficient method for treatment of Active & Abandoned Mine Drainage

CLLEEN's Guarantee  
 To work as stated or your money back

Humanitarian Aid/ Disaster Relief...  
 CLLEEN requires NO outside power source

CLLEEN's smaller skids for  
 \*military  
 \*cruise ship  
 water desalination

Oil, Gas, Minesite Operations  
 CLLEEN is your drinking water solution

# The EC Process in Practice



Twin train 500-gpm EC coupled with UF and RO



Vacuum Clarifier - Secondary Separation



Untreated



EC Treated 5 Min



Settling 10 Min



Settling



Final Waste Sludge

www.waterdesalinationplants.com

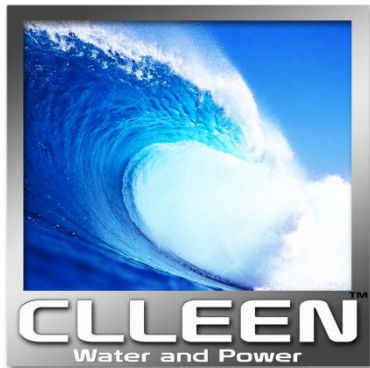

## Electrocoagulation (EC):

- Metal anode dissolution
- Coupled to complementary cathode reaction that generates OH-
- Metal hydroxides form
- Dissolved contaminants adsorbed

## EC process:

- Is salt-free, pH-neutral
- It avoids counterions of standard coagulating agents eg:  $Fe(Cl)_3$  and  $Al_2(SO_4)_3$

## Is particularly effective in removal of wide range of:

- Natural organic matter
- Dissolved solids
- Particulates & micro-organisms from drinking water

## Metal hydroxide precipitates have large surface area (~500m<sup>2</sup>/g):

- Contaminants are physically or chemically adsorbed

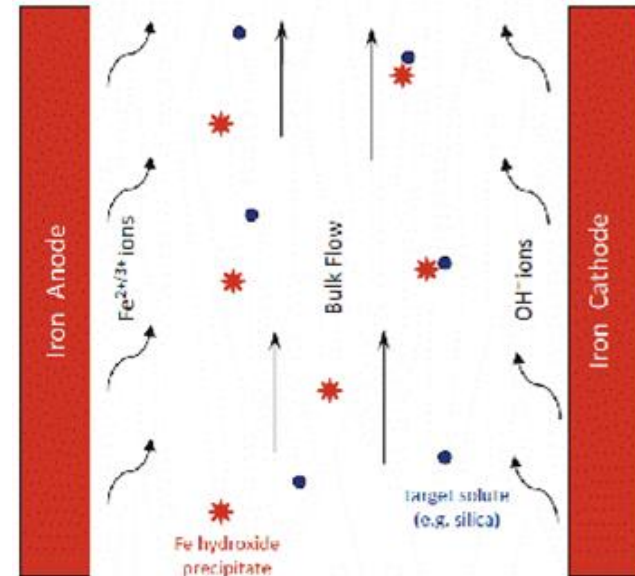

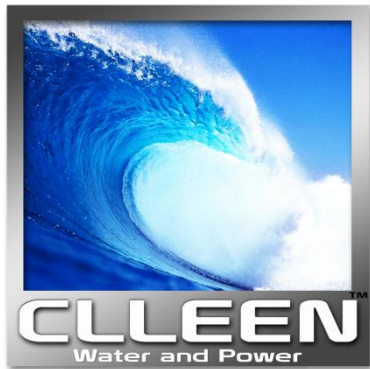

## Ultra Filtration

- Advanced ceramic UF design
- Separates contaminants down to 0.05 microns (50 nano meters)
- Twice membrane flow in same footprint of other membranes
- Maintenance of consistent trans-membrane pressure gradient through entire system

## Result

- High level of control
- Even membrane caking
- Higher flow rates



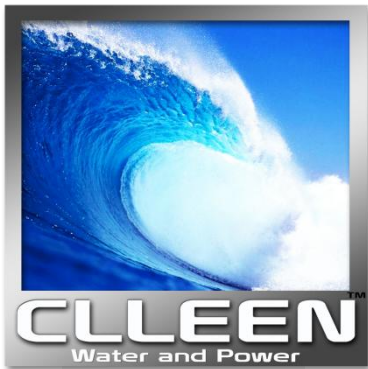

## Vacuum Clarification

- Pulls or 'stretches' water inside tower
- Results in bursting of small bubbles supporting coagulated contaminants

## Output

- Sludge accumulates bottom of VC
- Automatic removal in 23-25% solids consistency state
- Water recaptured for further use



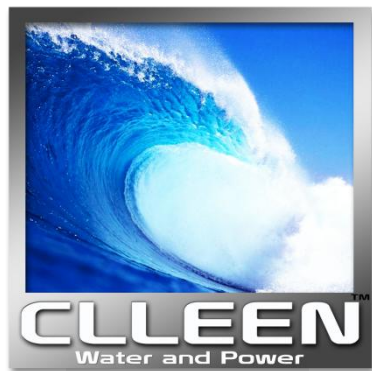

## CLLEEN™ Multi-stage Flash Distillation (MSF)

- Majority of desalination in world is MSF
- Proven technology
- Handles much higher concentrations of TDS than any RO

## CLLEEN™ MSF system removes

- Short carbon chain contaminants
- Solubles such as sodium chloride



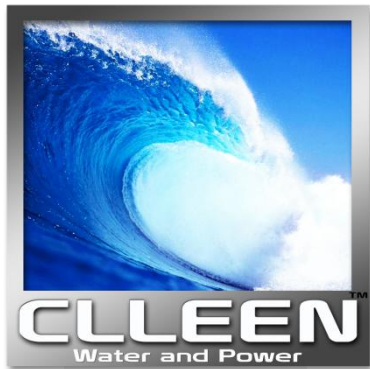

## EC-CLLEEN™ Water and Power handles waters:

- With very high TDS levels
- For a wide range of applications
- Where the functional advantages of EC are maintained for conversion of ionic metals to earth friendly oxide forms
- By harvesting valuables
- Producing bio-friendly sludge and
- CLLEEN™ Crystallisation for dry salts
- Can set up a stationary site near frac flow-back water lagoons
- Or can mobilize on 5 tractor-trailers and treat lagoon to lagoon
- EC unit sits in front of treatment train
- EC preceded only by screening & pH adjustment if necessary

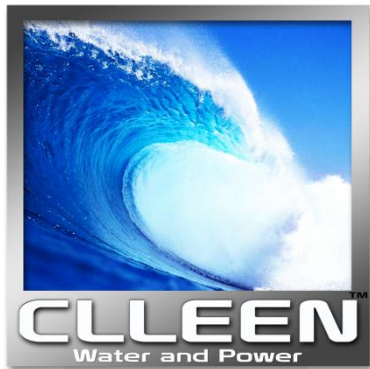

## Who to contact:

Your authorised CLLEEN™ Water and Power reseller

or

CLLEEN™ Water and Power International Sales & Marketing:

**Jan Pagonis**

CEO Australia Global Trading Pty Ltd

p: +61 409 918 876

e: [jan@waterdesalinationplants.com](mailto:jan@waterdesalinationplants.com)

or

CLLEEN™ Water and Power is a division of **Anthony Migyanka, Inc.**

a: 9400 N. MacArthur Blvd.

#124-627 Irving, Texas 75063 USA

p: 978-CLLEEN1 (978-255-3361)

e: [info@clleen.com](mailto:info@clleen.com)

www.waterdesalinationplants.com